



FCC Verification Test Report

According to

47 CFR, Part 2, Part 15, CISPR PUB. 22

Applicant : Aplus Technology Co., Ltd

Address : 7G10, No.5, Sec. 5, Xin-Yi road, Xin-Yi District, 11010,
Taipei, Taiwan

Equipment : 5 INCH IR SPEED DOME

Model No. : APTZ20Z30-M-POE, APTZ20Z20
APTZxxZxx-xyzuab(x= 1-9 or blank; y= 0-9;z= 0-9; u=
A-Z or blank; v= N,P or blank; a= C,N or blank; b= l or
blank)

Approved by:

Miro Chueh
EMC/RF B.U. Manager



FCC TEST REPORT

Issued by:

Cerpass Technology (Suzhou) Co.,Ltd

No.66,Tangzhuang Road, Suzhou Industrial Park, Jiangsu 215006, China

Tel:86-512-6917-5888

Fax:86-512-6917-5666

The test record, data evaluation & Equipment. Under Test configurations represented herein are true and accurate accounts of the measurements of the samples EMC characteristics under the conditions specified in this report.

Laboratory Accreditation:

Cerpass Technology Corporation Test Laboratory

NVLAP LAB Code:	200954-0
TAF LAB Code:	1439

Cerpass Technology(SuZhou) Co., Ltd.

NVLAP LAB Code:	200814-0
CNAS LAB Code:	L5515



Contents

1. Summary of Test Procedure and Test Result	5
2. Test Configuration of Equipment under Test.....	6
2.1. Manufacturer and Factory	6
2.2. Feature of Equipment under Test	6
2.3. Test Manner	8
2.4. Description of Test System	8
2.5. General Information of Test	9
2.6. Measurement Uncertainty	10
3. Test of Conducted Emission	11
3.1. Test Limit.....	11
3.2. Test Procedures.....	11
3.3. Typical test Setup	12
3.4. Measurement equipment.....	12
3.5. Test Result and Data	13
3.6. Test Photographs.....	15
4. Test of Radiated Emission	16
4.1. Test Limit.....	16
4.2. Test Procedures.....	16
4.3. Typical test Setup	17
4.4. Measurement equipment.....	18
4.5. Test Result and Data (30MHz ~ 1000MHz).....	19
4.6. Test Result and Data (1000MHz ~ 18000MHz).....	21
4.7. Test Photographs (30MHz ~ 1000MHz)	23
4.8. Test Photographs (1000MHz ~ 18000MHz)	24
5. Photographs of EUT	25



1. Summary of Test Procedure and Test Result

Test Item	Normative References	Test Result
Conducted Emission	ANSI C63.4-2014 FCC Part 15 Subpart B	PASS
Radiated Emission	ANSI C63.4-2014 FCC Part 15 Subpart B	PASS



2. Test Configuration of Equipment under Test

2.1. Manufacturer and Factory

Aplus Technology Co., Ltd.

7G10, No.5, Sec. 5, Xin-Yi Road, Xin-Yi District, 11010, Taipei, Taiwan

2.2. Feature of Equipment under Test

Fourth edition

5 INCH IR SPEED DOME	Model No.:	APTZ20Z30-M-POE, APTZ20Z20 APTZxxZxx-xyzuab(x= 1-9 or blank; y= 0-9;z= 0-9; u= A- Z or blank; v= N,P or blank; a= C,N or blank; b= I or blank)
Remark	The add model name and the original model name are identical except the model name.	
Adapter	Model No.:	A24-3A
	Input :	120V~ 60Hz 88W
	Output :	24VAC 3000mA

Third edition

5 INCH IR SPEED DOME	Model No.:	APTZ20Z30-M-POE, APTZ20Z20 APTZxxZxx-xyzuab(x= 1-9 or blank; y= 0-9;z= 0-9; u= A-Z or blank; v= N,P or blank; a= C,N or blank; b= I or blank)
Remark	The add model name and the original model name are identical except the model name.	
Adapter	Model No.:	A24-3A
	Input :	120V~ 60Hz 88W
	Output :	24VAC 3000mA



Second edition:

5 INCH IR SPEED DOME	Model No.:	APTZ20Z30-M-POE, APTZ20Z20 APTZxxZxx-xyzuab(x= 1-9 or blank; y= 0-9;z= 0-9; u= A-Z or blank; v= N,P or blank; a= C,N or blank; b= I or blank)
Remark	The add model name and the original model name are identical except the model name.	
Adapter	Model No.:	A24-3A
	Input :	120V~ 60Hz 88W
	Output :	24VAC 3000mA

First edition:

5 INCH IR SPEED DOME	Model No.:	APTZ20Z30-M-POE, APTZ20Z20 APTZxxZxx-xyzuab(x= 1-9 or blank; y= 0-9;z= 0-9; u= A-Z or blank; v= N,P or blank; a= C,N or blank; b= I or blank)
Remark	APTZ20Z20-AHD was selected as the test model and its data have been recorded in this report. Their sales regions are different.	
Adapter	Model No.:	A24-3A
	Input :	120V~ 60Hz 88W
	Output :	24VAC 3000mA

Original:

IR HDCVI SPEED DOME	Model No.:	APTZxxZxx-AHD
Remark	APTZ20Z20-AHD was selected as the test model and its data have been recorded in this report. Their sales regions are different.	
Adapter	Model No.:	A24-3A
	Input :	120V~ 60Hz 88W
	Output :	24VAC 3000mA



2.3. Test Manner

Test Manner

- a During testing, the interface cables and equipment positions were varied according to ANSIC63.4-2014
- b The complete test system included the DVR, Monitor and EUT for for EMI test

The pre-test modes

Test Mode 1: Normal Operation

Select the worst case of the pre-test modes as the final test mode

Test Mode 1: Normal Operation

2.4. Description of Test System

No.	Device	Manufacturer	Model No.	Description
1	Monitor	PTS	PTS-1401C	Non-Shielded,1.8m
2	DVR	DAHUA	DVR5208	Non-Shielded,1.5m

Item	Cable	Quantity	Description
A	BNC Cable	1	Shielded, >3.0m
B	BNC Cable	1	Shielded, >3.0m



2.5. General Information of Test

<input type="checkbox"/>	Test Site	Cerpass Technology Corporation Test Laboratory Address: No.10, Ln. 2, Lianfu St., Luzhu Dist., Taoyuan City 33848, Taiwan (R.O.C.) Tel:+886-3-3226-888 Fax:+886-3-3226-881 Address: No.68-1, Shihbachongsi, Shihding Township, New Taipei City 223, Taiwan, R.O.C. Tel: +886-2-2663-8582
	FCC	TW1079, TW1061,390316, 228391, 641184
	IC	4934B-1, 4934E-1, 4934E-2
	VCCI	T-2205 for Telecommunication Test C-4663 for Conducted emission test R-3428, R-4218 for Radiated emission test G-812, G-813 for radiated disturbance above 1GHz
<input checked="" type="checkbox"/>	Test Site	Cerpass Technology (Suzhou) Co.,Ltd Address: No.66,Tangzhuang Road, Suzhou Industrial Park, Jiangsu 215006, China Tel: +86-512-6917-5888 Fax: +86-512-6917-5666
	FCC	331395
	IC	7290A-1, 7290A-2
	VCCI	T-1945 for Telecommunication Test C-2919 for Conducted emission test R-2670 for Radiated emission test G-227 for radiated disturbance above 1GHz
Frequency Range Investigated:	Conducted: from 150kHz to 30 MHz Radiation: from 30 MHz to 18000MHz	
Test Distance:	The test distance of radiated emission below 1GHz from antenna to EUT is 10 M. The test distance of radiated emission above 1GHz from antenna to EUT is 3 M.	



2.6. Measurement Uncertainty

Where relevant, the following measurement uncertainty levels have been estimated for tests performed on the EUT as specified in CISPR 16-4-2:

Measurement	Frequency	Uncertainty
Conducted emissions(LINE)	9KHz-30MHz	+/- 0.7738 dB
Conducted emissions(NEUTRAL)	9KHz-30MHz	+/- 0.7886 dB

Measurement	Polarity	Frequency	Uncertainty
Radiated emissions (below 1GHz)	H	30MHz ~ 200MHz	+/- 3.8909dB
		200MHz ~1000MHz	+/- 3.6555dB
	V	30MHz ~ 200MHz	+/- 3.8948dB
		200MHz ~1000MHz	+/- 3.6538dB
Radiated emissions (above 1GHz)	H	1000MHz ~18000MHz	+/- 3.8948 dB
		18000MHz ~40000MHz	+/-3.8844dB
	V	1000MHz ~18000MHz	+/- 3.8906dB
		18000MHz ~40000MHz	+/- 3.8744dB

This uncertainty represents an expanded uncertainty expressed at approximately the 95% confidence level using a coverage factor of k=2.

Consistent with industry standard (e.g. CISPR 22: 2008, clause 11, Measurement Uncertainty) determining compliance with the limits shall be base on the results of the compliance measurement. Consequently the measure emissions being less than the maximum allowed emission result in this be a compliant test or passing test.



3. Test of Conducted Emission

3.1. Test Limit

Conducted Emissions were measured from 150 kHz to 30 MHz with a bandwidth of 9 KHz on the 120 VAC power and return leads of the EUT according to the methods defined in ANSI C63.4 Section 3.1. The EUT was placed on a nonmetallic stand in a shielded room 0.8 meters above the ground plane as shown in section 1.2. The interface cables and equipment positioning were varied within limits of reasonable applications to determine the position produced maximum conducted emissions.

For a Class A digital device that is designed to be connected to the public utility (AC) power line, the radio frequency voltage that is conducted back onto the AC power line on any frequency or frequencies within the band 150 kHz to 30 MHz shall not exceed the limits in the following table, as measured using a 50 μ H/50 ohms LISN. Compliance with the provisions of this paragraph shall be based on the measurement of the radio frequency voltage between each power line and ground at the power terminal. The lower limit applies at the boundary between the frequency ranges.

Conducted Emission Limits:

Frequency (MHz)	Quasi Peak (dB μ V)	Average (dB μ V)
0.15 – 0.5	79	66
0.5 – 30.0	73	60

3.2. Test Procedures

- a. The EUT was placed 0.4 meter from the conducting wall of the shielding room was kept at least 80 centimeters from any other grounded conducting surface.
- b. Connect EUT to the power mains through a line impedance stabilization network (LISN).
- c. All the support units are connecting to the other LISN.
- d. The LISN provides 50 ohm coupling impedance for the measuring instrument.
- e. The FCC states that a 50 ohm, 50 micro-Henry LISN should be used.
- f. Both sides of AC line were checked for maximum conducted interference.
- g. The frequency range from 150 kHz to 30 MHz was searched.
- h. Set the test-receiver system to Peak Detect Function and Specified Bandwidth with Maximum Hold Mode.



3.3. Typical test Setup

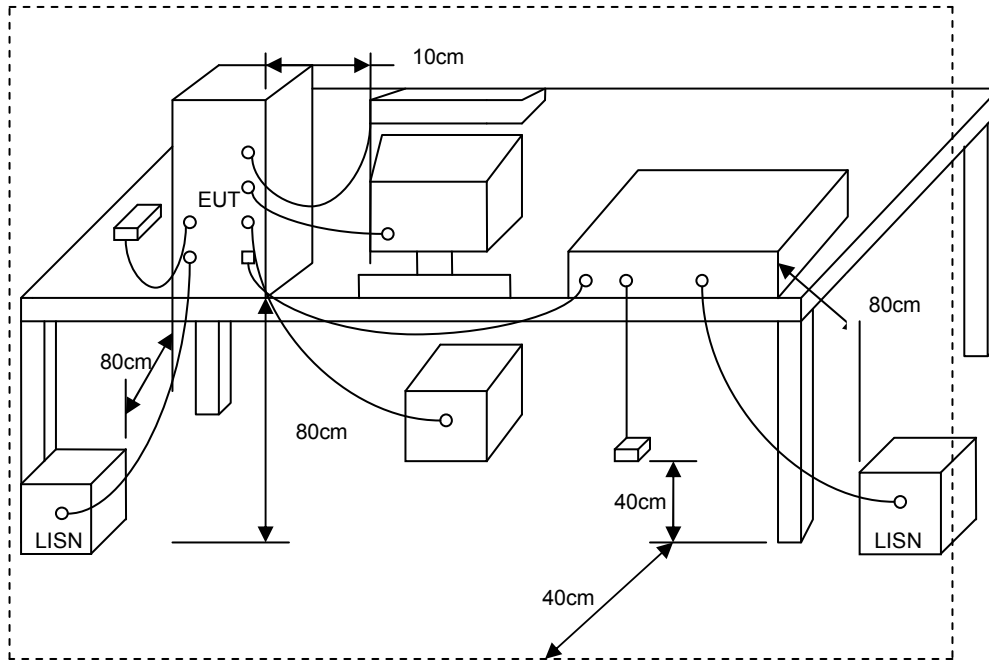

3.4. Measurement equipment

Instrument/Ancillary	Manufacturer	Model No.	Serial No.	Calibration Date	Valid Date.
Test Receiver	R&S	ESCI	100565	2014.03.24	2015.03.23
AMN	R&S	ESH2-Z5	100182	2013.09.11	2014.09.10
Two-Line V-Network	R&S	ENV216	100325	2013.12.04	2014.12.03
ISN	FCC	FCC-TLISN-T2-02	20379	2014.03.24	2015.03.23
ISN	FCC	FCC-TLISN-T4-02	20380	2014.03.24	2015.03.23
ISN	FCC	FCC-TLISN-T8-02	20381	2014.03.24	2015.03.23
ISN	TESEQ	ISN ST08	30175	2014.03.24	2015.03.23
Current Probe	R&S	EZ-17	100303	2014.04.04	2015.04.03
Passive Voltage Probe	R&S	ESH2-Z3	100026	2014.03.24	2015.03.23
Pulse Limiter	R&S	ESH3-Z2	100529	2014.03.24	2015.03.23
Temperature/ Humidity Meter	Zhicheng	ZC1-11	CEP-TH-004	2014.03.31	2015.03.30



3.5. Test Result and Data

Test Mode :	Mode 1: Normal Operation		
AC Power :	AC 120V/60Hz	Phase :	LINE
Equipment :	5 INCH IR SPEED DOME	Model No :	APTZ20Z20-M-POE
Temperature :	23°C	Humidity :	52%
Pressure(mbar) :	1002	Date :	2014/05/15

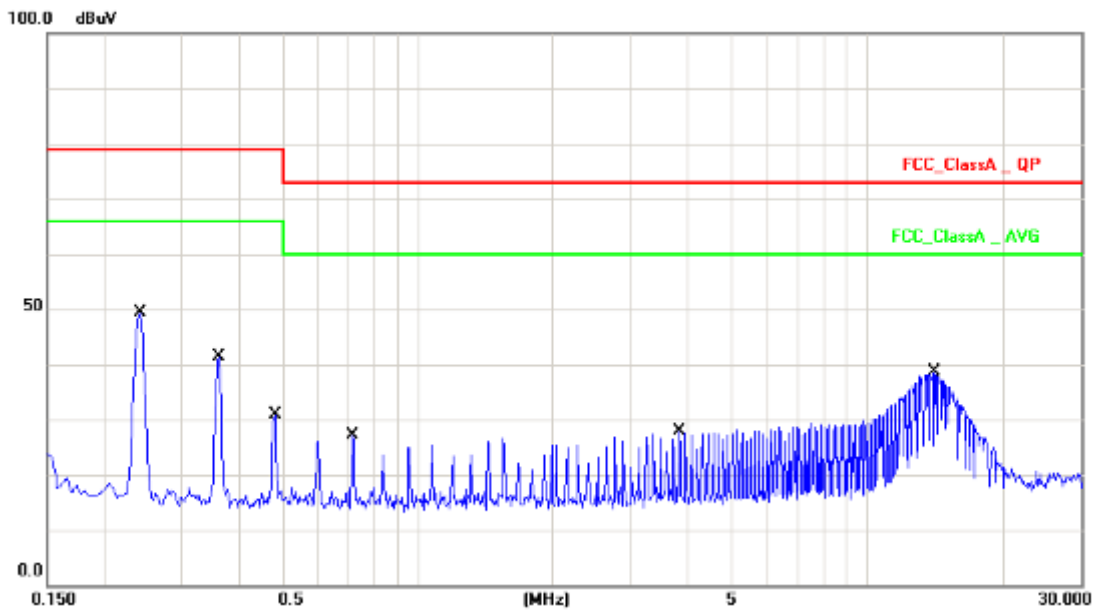

No.	Frequency (MHz)	Factor (dB)	Reading (dBuV)	Level (dBuV)	Limit (dBuV)	Margin (dB)	Detector
1	0.2420	10.13	39.09	49.22	79.00	-29.78	QP
2	0.2420	10.13	37.09	47.22	66.00	-18.78	AVG
3	0.3620	10.15	28.34	38.49	79.00	-40.51	QP
4	0.3620	10.15	28.10	38.25	66.00	-27.75	AVG
5	0.4820	10.15	16.79	26.94	79.00	-52.06	QP
6	0.4820	10.15	16.18	26.33	66.00	-39.67	AVG
7	0.7180	10.16	14.44	24.60	73.00	-48.40	QP
8	0.7180	10.16	15.06	25.22	60.00	-34.78	AVG
9	3.8380	10.22	15.11	25.33	73.00	-47.67	QP
10	3.8380	10.22	13.99	24.21	60.00	-35.79	AVG
11	14.1540	10.49	26.76	37.25	73.00	-35.75	QP
12	14.1540	10.49	28.73	39.22	60.00	-20.78	AVG

Note: Measurement Level = Reading Level + Correct Factor



Test Mode :	Mode 1: Normal Operation		
AC Power :	AC 120V/60Hz	Phase :	NEUTRAL
Equipment :	5 INCH IR SPEED DOME	Model No :	APTZ20Z20-M-POE
Temperature :	23°C	Humidity :	52%
Pressure(mbar) :	1002	Date :	2014/05/15

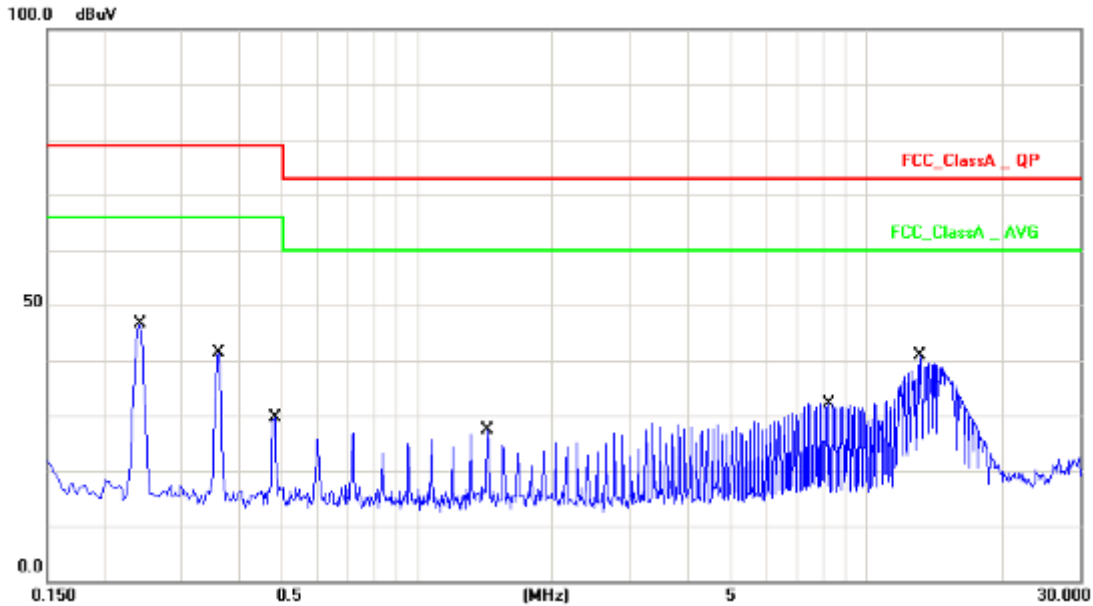

No.	Frequency (MHz)	Factor (dB)	Reading (dBuV)	Level (dBuV)	Limit (dBuV)	Margin (dB)	Detector
1	0.2420	10.13	36.09	46.22	79.00	-32.78	QP
2	0.2420	10.13	34.98	45.11	66.00	-20.89	AVG
3	0.3620	10.15	29.85	40.00	79.00	-39.00	QP
4	0.3620	10.15	28.97	39.12	66.00	-26.88	AVG
5	0.4820	10.15	18.96	29.11	79.00	-49.89	QP
6	0.4820	10.15	18.05	28.20	66.00	-37.80	AVG
7	1.4380	10.18	15.05	25.23	73.00	-47.77	QP
8	1.4380	10.18	14.05	24.23	60.00	-35.77	AVG
9	8.2739	10.27	14.06	24.33	73.00	-48.67	QP
10	8.2739	10.27	12.99	23.26	60.00	-36.74	AVG
11	13.1900	10.43	22.98	33.41	73.00	-39.59	QP
12	13.1900	10.43	22.08	32.51	60.00	-27.49	AVG

Note: Measurement Level = Reading Level + Correct Factor

Test engineer: Seben



3.6. Test Photographs

Front View



Rear View

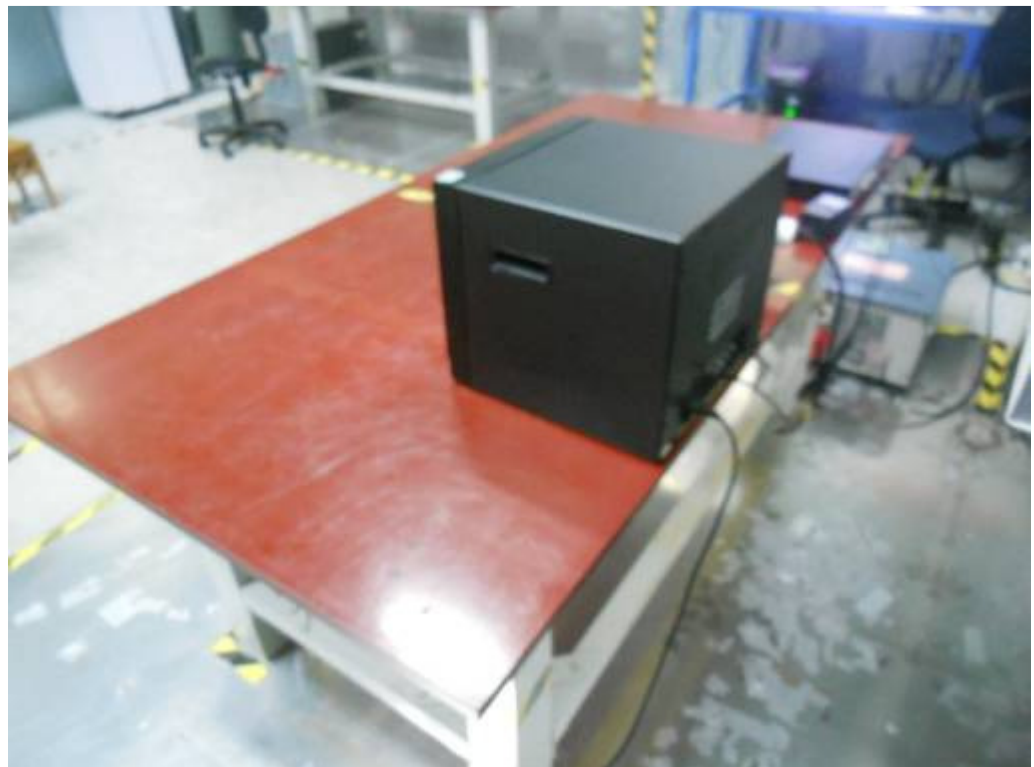



4. Test of Radiated Emission

4.1. Test Limit

The EUT was placed on a nonmetallic stand in the open-field site, 0.8 meter above the ground plane, as shown in section 2.2. The interface cables and equipment positions were varied within limits of reasonable applications to determine the positions producing maximum radiated emissions.

For unintentional device, according to § 15.109(b), for Class A digital devices, the field strength of radiated emissions from unintentional radiators at a distance of 10 meters shall not exceed the following values:

Frequency (MHz)	Distance Meters	Radiated (μ V / M)	Radiated (dB μ V / M)
30-88	10	90	39.0
88-216	10	150	43.5
216-960	10	210	46.4
Above 960	10	300	49.5

For unintentional device, according to CISPR PUB.22, for Class A digital devices, the general requirement of field strength of radiated emissions from intentional radiators at a distance of 10 meters shall not exceed the below table.

Frequency (MHz)	Distance Meters	Radiated (dB μ V / M)
30-230	10	40
230-1000	10	47

4.2. Test Procedures

- The EUT was placed on a Rota table top 0.8 meter above ground.
- The EUT was set 3/10 meters from the interference receiving antenna which was mounted on the top of a variable height antenna tower.
- The table was rotated 360 degrees to determine the position of the highest radiation.
- The antenna is a half wave dipole and its height is varied between one meter and four meters above ground to find the maximum value of the field strength both horizontal polarization and vertical polarization of the antenna are set to make the measurement.
- For each suspected emission the EUT was arranged to its worst case and then tune the antenna tower (from 1 M to 4 M) and turn table (from 0 degree to 360 degrees) to find the maximum reading.
- Set the test-receiver system to Peak Detect Function and specified bandwidth with Maximum Hold Mode.
- If the emission level of the EUT in peak mode was 6 dB lower than the limit specified, then testing will be stopped and peak values of EUT will be reported, otherwise, the emissions which do not have 6 dB margin will be repeated one by one using the quasi-peak method and reported.



4.3. Typical test Setup

Below 1GHz Test Setup

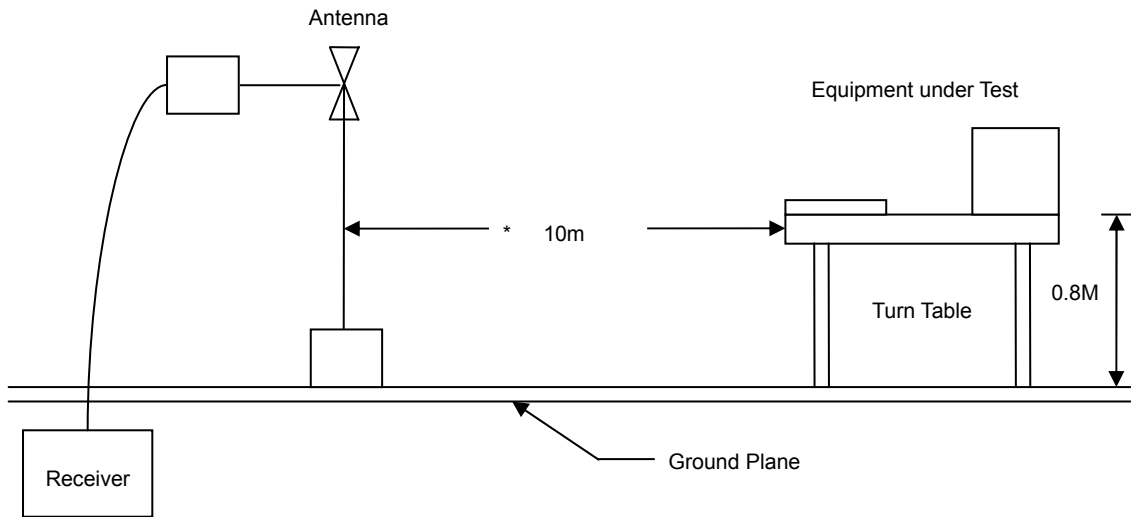

Above 1GHz Test Setup

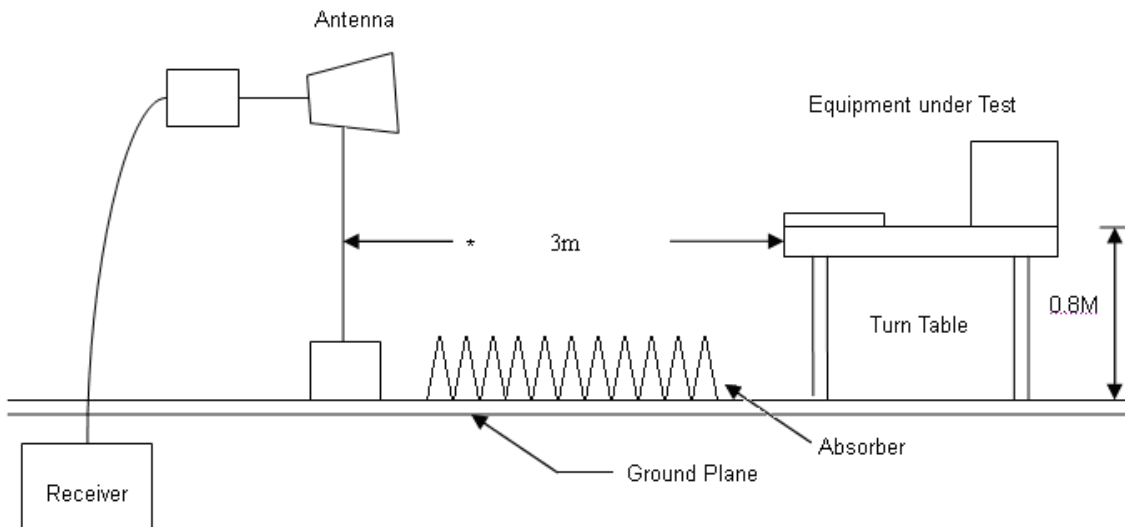

**4.4. Measurement equipment**

Instrument/Ancillary	Manufacturer	Model No.	Serial No.	Calibration Date	Valid Date.
EMI Test Receiver	R&S	ESCI	100563	2014.02.10	2015.02.09
H64 Preamplifier	HP	8447F	3113A05582	2014.03.24	2015.03.23
Preamplifier	Agilent	8449B	3008A02342	2014.03.24	2015.03.23
Ultra Broadband Antenna	R&S	HL562	100362	2014.05.02	2015.05.01
Broad-Band Horn Antenna	Schwarzbeck	BBHA9120D	9120D-619	2014.05.02	2015.05.01
Broad-Band Horn Antenna	Schwarzbeck	BBHA9170	9170-348	2013.11.04	2014.11.03
Spectrum Analyzer	R&S	FSP40	100324	2014.03.23	2015.03.24
Temperature/ Humidity Meter	Zhicheng	ZC1-11	CEP-TH-002	2014.03.31	2015.03.30



4.5. Test Result and Data (30MHz ~ 1000MHz)

Test Mode :	Mode 1: Normal Operation		
AC Power :	AC 120V/60Hz	Ant. Polarization:	Horizontal
Equipment :	5 INCH IR SPEED DOME	Model No :	APTZ20Z20-M-POE
Temp :	23°C	Humidity :	52%
Pressure(mbar) :	1002	Date :	2014/04/14

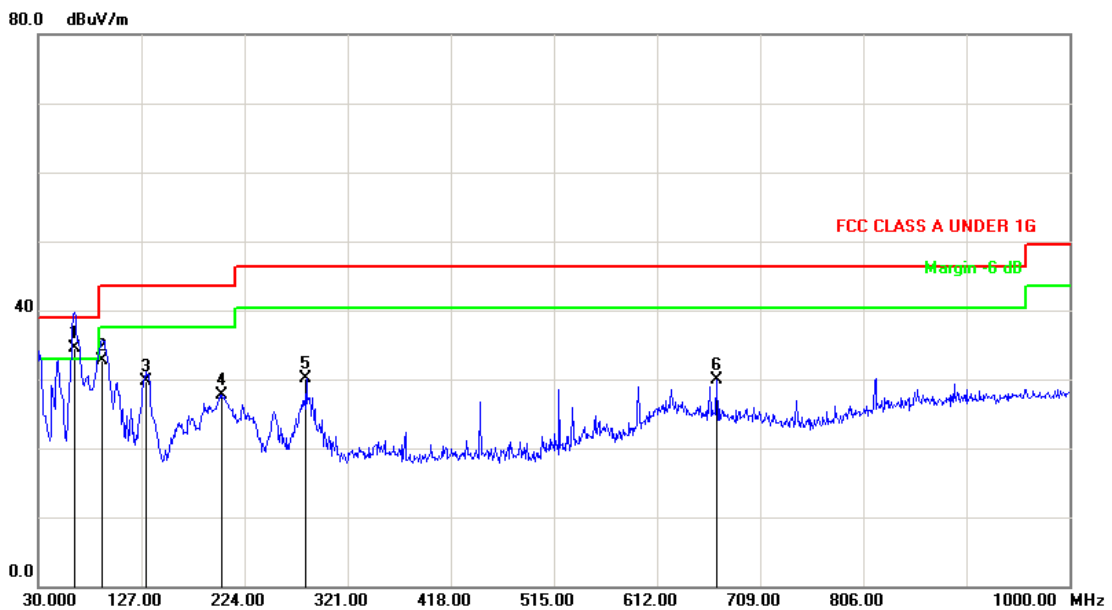

No.	Frequency (MHz)	Factor (dB/m)	Reading (dBuV)	Level (dBuV/m)	Limit (dBuV/m)	Margin (dB)	Det.	Height (cm)	Azimuth (deg)
1	63.9500	-13.84	48.42	34.58	39.00	-4.42	QP	301	360
2	90.1400	-15.19	47.88	32.69	43.50	-10.81	QP	400	147
3	131.8499	-9.83	39.56	29.73	43.50	-13.77	QP	400	208
4	202.6599	-10.27	37.93	27.66	43.50	-15.84	QP	300	216
5	282.1999	-8.99	39.16	30.17	46.40	-16.23	QP	300	119
6	668.2599	0.23	29.59	29.82	46.40	-16.58	QP	100	319

Note: Measurement Level = Reading Level + Correct Factor



Test Mode :	Mode 1: Normal Operation		
AC Power :	AC 120V/60Hz	Ant. Polarization:	Vertical
Equipment :	5 INCH IR SPEED DOME	Model No :	APTZ20Z20-M-POE
Temp :	23°C	Humidity :	52%
Pressure(mbar) :	1002	Date :	2014/04/14

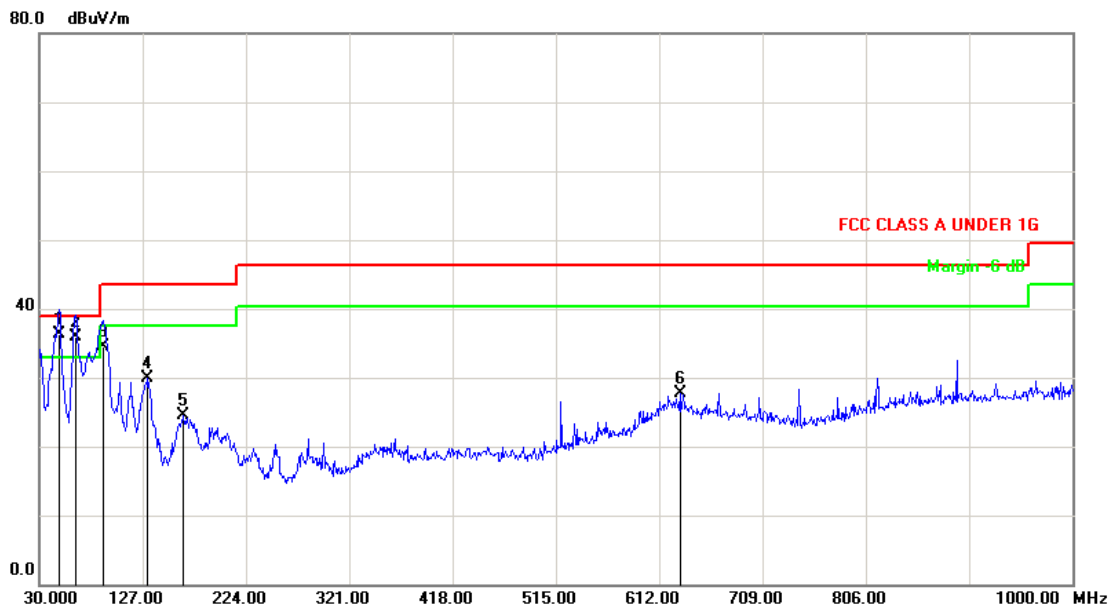

No.	Frequency (MHz)	Factor (dB/m)	Reading (dBuV)	Level (dBuV/m)	Limit (dBuV/m)	Margin (dB)	Det.	Height (cm)	Azimuth (deg)
1	49.1900	-10.76	47.16	36.40	39.00	-2.60	QP	100	63
2	64.3700	-13.97	49.97	36.00	39.00	-3.00	QP	100	289
3	90.1400	-15.19	49.75	34.56	43.50	-8.94	QP	200	140
4	131.8500	-9.83	39.79	29.96	43.50	-13.54	QP	400	353
5	164.8300	-11.76	36.32	24.56	43.50	-18.94	QP	200	57
6	631.4000	1.12	26.56	27.68	46.40	-18.72	QP	200	169

Note: Measurement Level = Reading Level + Correct Factor



4.6. Test Result and Data (1000MHz ~ 18000MHz)

Test Mode :	Mode 1: Normal Operation		
AC Power :	AC 120V/60Hz	Ant. Polarization:	Horizontal
Equipment :	5 INCH IR SPEED DOME	Model No :	APTZ20Z20-M-POE
Temp :	23°C	Humidity :	52%
Pressure(mbar) :	1002	Date :	2014/05/13

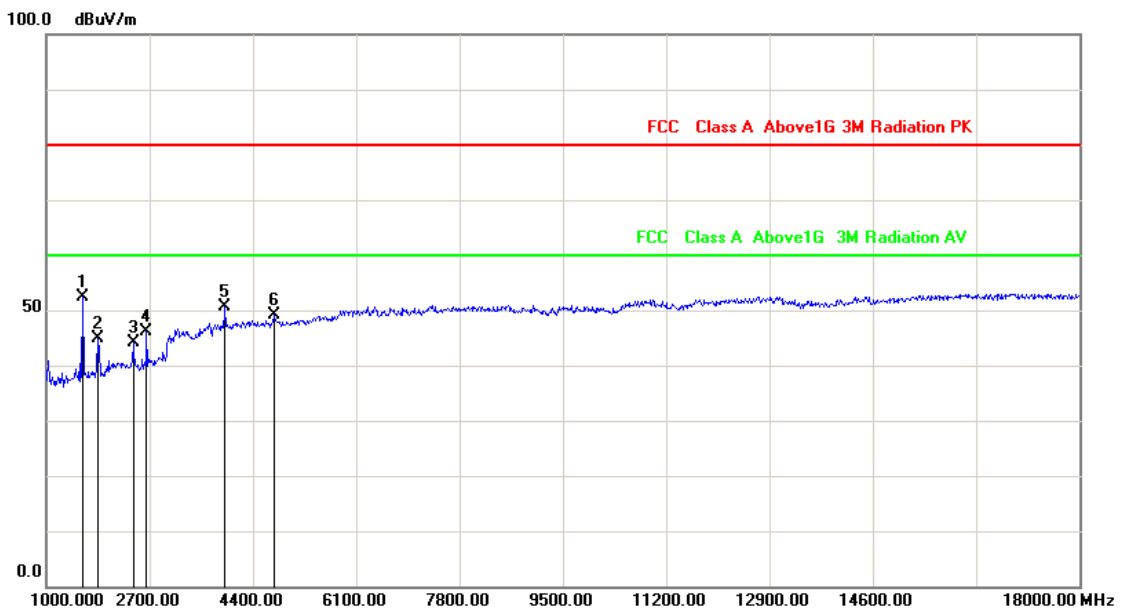

No.	Frequency (MHz)	Factor (dB/m)	Reading (dBuV)	Level (dBuV/m)	Limit (dBuV/m)	Margin (dB)	Det.	Height (cm)	Azimuth (deg)
1	1595.000	-4.39	56.79	52.40	80.00	-27.60	peak	100	261
2	1850.000	-3.33	48.29	44.96	80.00	-35.04	peak	100	284
3	2428.000	-1.27	45.43	44.16	80.00	-35.84	peak	100	38
4	2649.000	-0.53	46.57	46.04	80.00	-33.96	peak	100	243
5	3941.000	4.14	46.37	50.51	80.00	-29.49	peak	100	24
6	4740.000	6.20	42.89	49.09	80.00	-30.91	peak	100	143

Note: Measurement Level = Reading Level + Correct Factor



4.7. Test Photographs (30MHz ~ 1000MHz)

Front View



Rear View

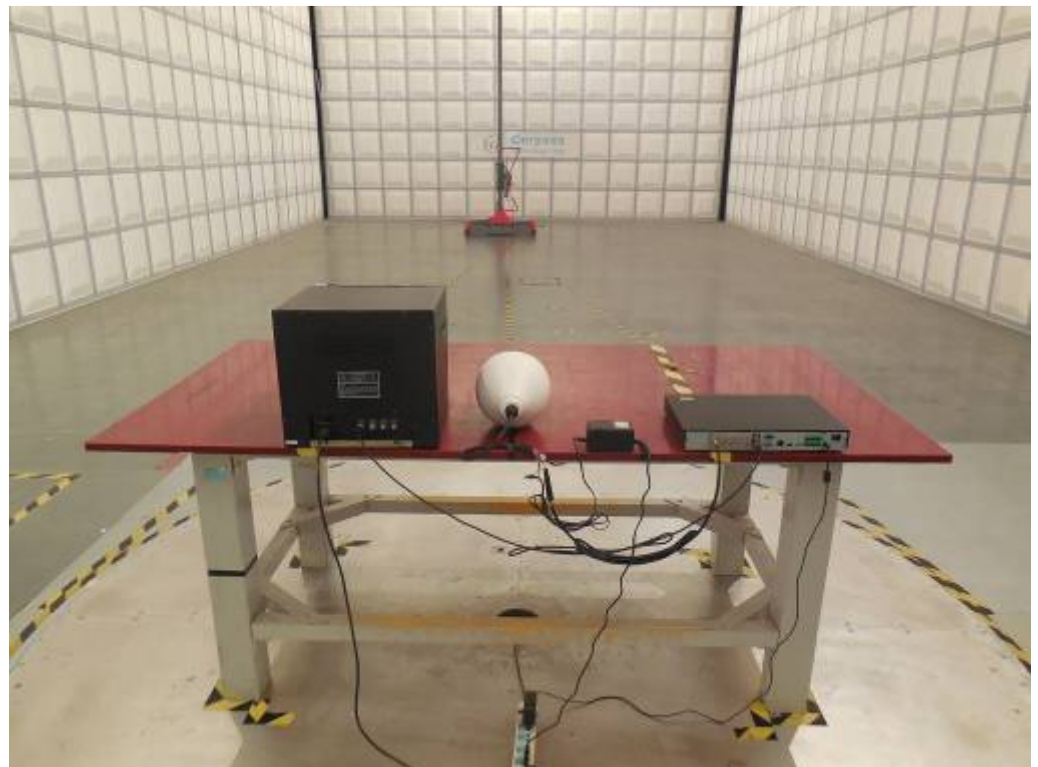



4.8. Test Photographs (1000MHz ~ 18000MHz)

Front View



Rear View

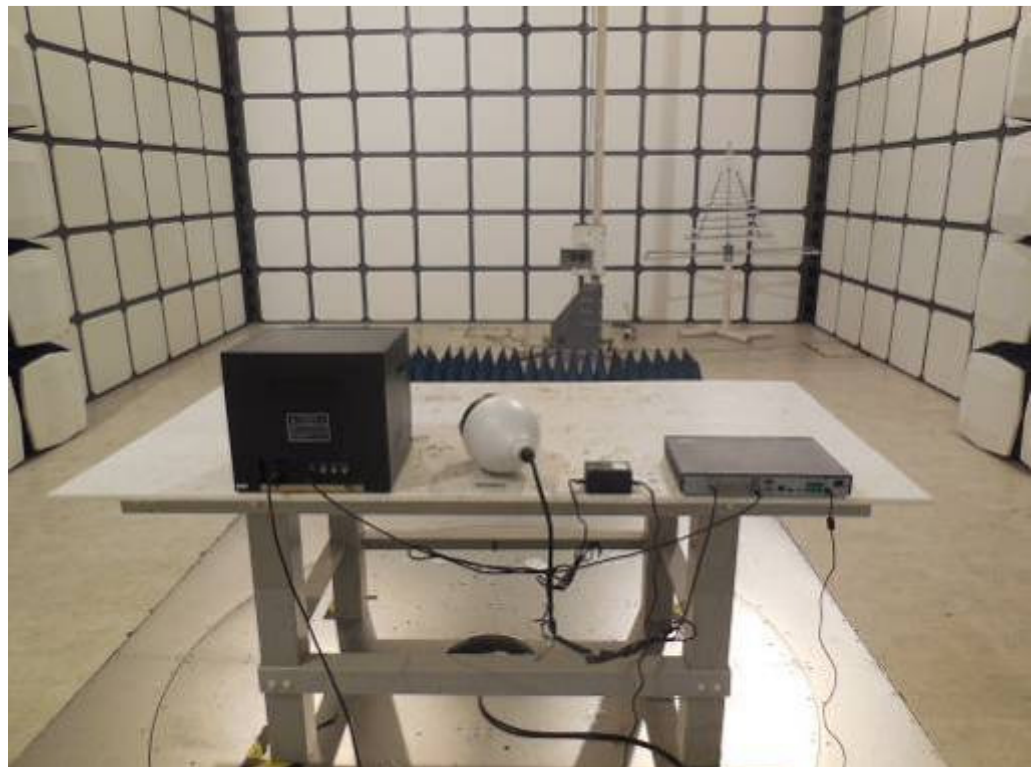



5. Photographs of EUT

1) EUT Photo



2) EUT Photo

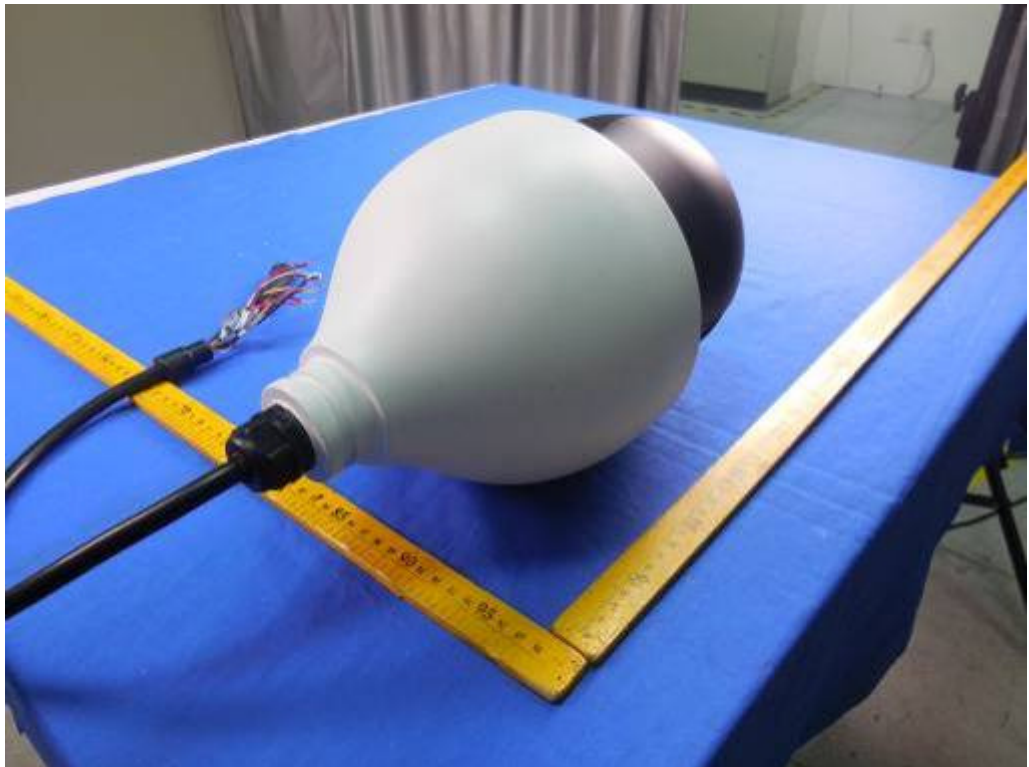



3) EUT Photo

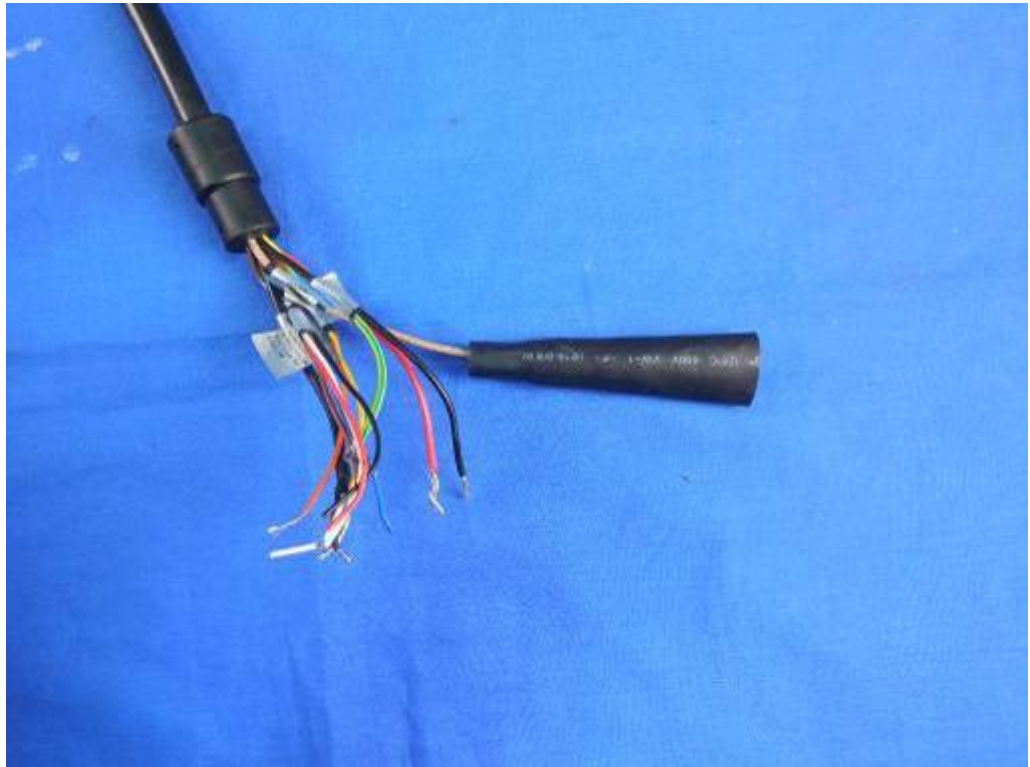

4) EUT Photo(Adapter)





5) EUT Photo(Adapter)



6) EUT Photo(Adapter)

